



# motorcycle battery 504 12

YTX5L-BS 12V 4Ah; 70A (EN)



The Q-Batteries motorcycle YT series with AGM (Absorbent Glass Mat) technology is wet or dry pre-charged. The batteries convince with a good charging acceptance and vibration resistant performance.

## Application:

motorcycles, lawn mowers, jet skies

## Features:

- maintenance free
- vibration resistant
- AGM technology (Absorbent Glass Mat)

## Specification:

Voltage:	12V
Capacity:	4Ah
CCA (Cold Cranking Amps):	70A (EN)
Weight:	2,2 kg +/- 3%
Terminal:	Y5
Circuit:	0 (positive pole right)
Hold down:	B00

## Dimensions:

113mm Length x 70mm Width x 105 mm Height



Base hold down B00

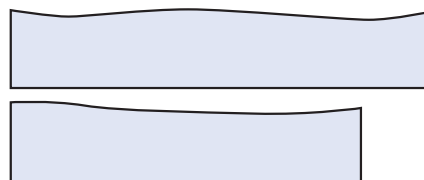

Layout 0

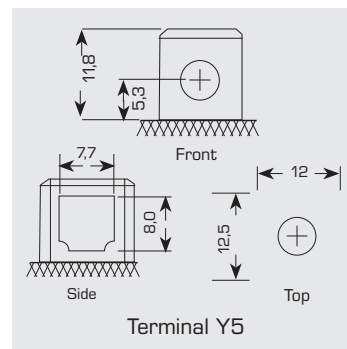
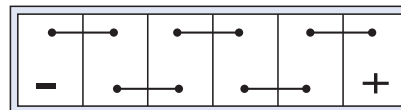

Liability is excluded for all printing errors and omissions.  
Subject to errors and prior sale. Illustration similar.  
07/2017